

V00101

Die; 2222; 940; M; 3B; T07; 10mW; 0.175 X 0.215



Features:

- Chip Technology: GaAs VCSEL
- Laser Wavelength: 940 nm
- Optical Power Class: 10 mW
- Radiation Profile: Multi-Mode
- ESD: 500 V acc. to ANSI/ESDA/JEDEC JS-001 (HBM, Class 1B)

Ordering Information

Description	Operating Mode: $T_a = 25^\circ\text{C}$; $I_F = 15 \text{ mA}$; DC = 100%	Ordering Code
Die; 2222; 940; M; 3B; T07; 10mW; 0.175 X 0.215	10.5 mW	V00101



COMPLIES WITH IEC 60825-1, 3rd EDITION MAY 2014.
COMPLIES WITH 21 CFR 1040.10 AND 1040-10.11 EXCEPT FOR DEVIATIONS PURSUANT TO LASER
NOTICE NO.50 DATED 27 MAY 2001.

Maximum Ratings

$T_a = 25^\circ\text{C}$

Parameter	Symbol		Values
Operation/Solder temperature	T_S	min.	-40°C
DC = 100%		max.	100°C
Storage temperature	T_{stg}	min.	-40°C
		max.	110°C
Forward current	I_f	max.	22 mA
Direct current operation; DC = 100%; $T_S = 25^\circ\text{C}$			
Reverse Voltage	Not designed for reverse operation		
ESD withstand voltage	V_{ESD}	max.	500 V
acc. to ANSI/ESDA/JEDEC JS-001 (HBM, Class 1B)			

Note: Stresses beyond those listed under Absolute Maximum Ratings may cause permanent damage to the device.

Characteristics

$T_a = 25^\circ\text{C}$, $I_F = 15 \text{ mA}$; DC = 100%

Parameter	Symbol		Values
Forward voltage	V_F	typ.	2.0 V
Output power	Φ	typ.	10.5 mW
Threshold current	I_{th}	typ.	1.8 mA
Slope efficiency	SE	typ.	0.8 W / A
Power conversion efficiency	η	typ.	36%
Peak wavelength	λ_{peak}	min.	930 nm
		typ.	940 nm
		max.	950 nm
Spectral bandwidth at FWHM (50% of Φ_{max})	λ_{FWHM}	typ.	2 nm
Temperature coefficient of wavelength	TC_λ	typ.	0.066 nm / K
Field of view at FWHM (50% of Φ_{max})	ϕ_x	typ.	17°
	ϕ_y	typ.	17°

Relative Spectral Emission ¹⁾

$$\Phi_{\text{rel}} = f(\lambda); I_F = 15 \text{ mA}$$

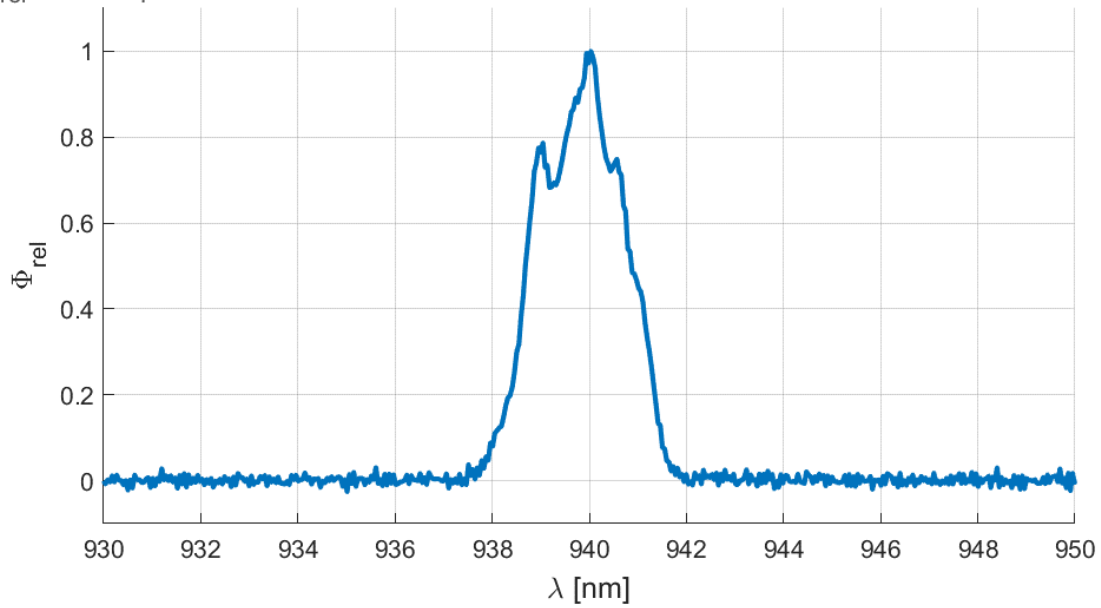
**Radiation Characteristics ¹⁾**

$$\Phi_{\text{rel}} = f(\phi); T_S = 25 \text{ }^\circ\text{C}$$

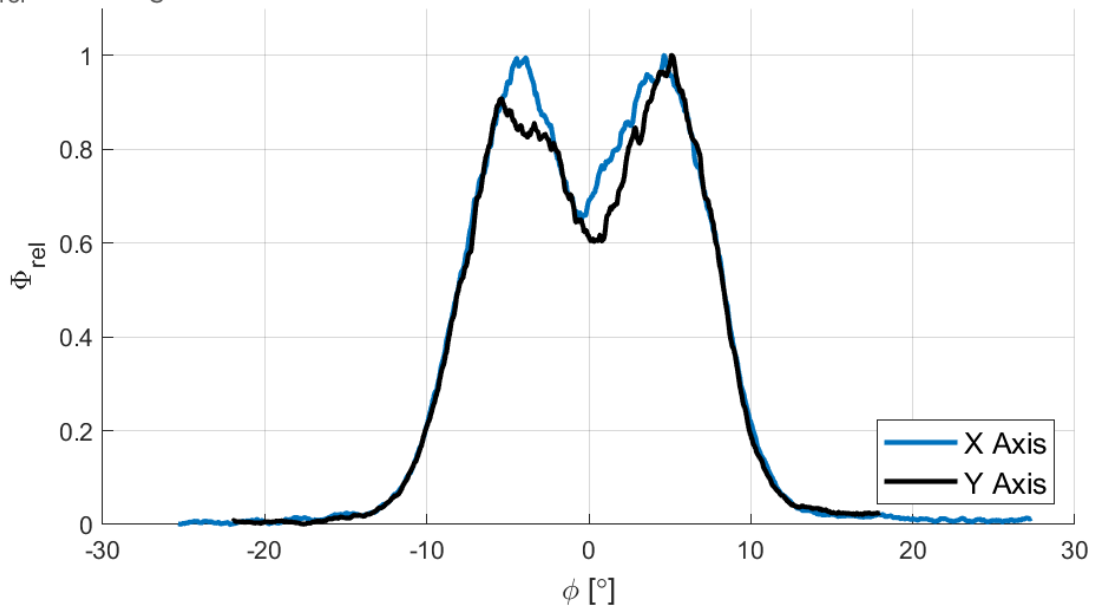

Forward Voltage ^{1) 2)}

$V_F = f(I_F); T_S = 25\text{ °C}; DC = 100\%$

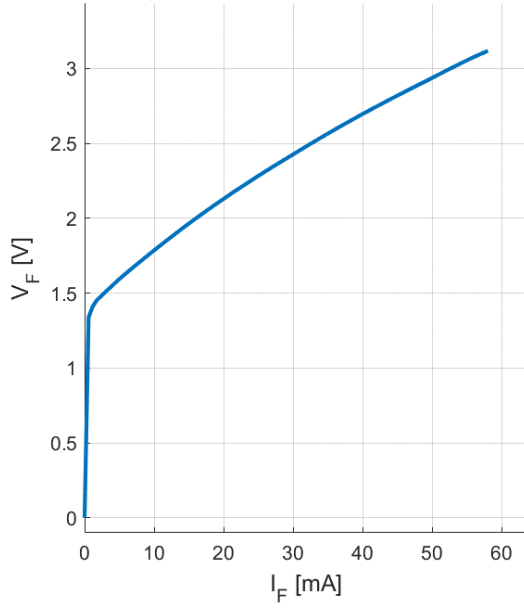

Optical Output Power ^{1) 2)}

$\Phi = f(I_F); T_S = 25\text{ °C}; DC = 100\%$

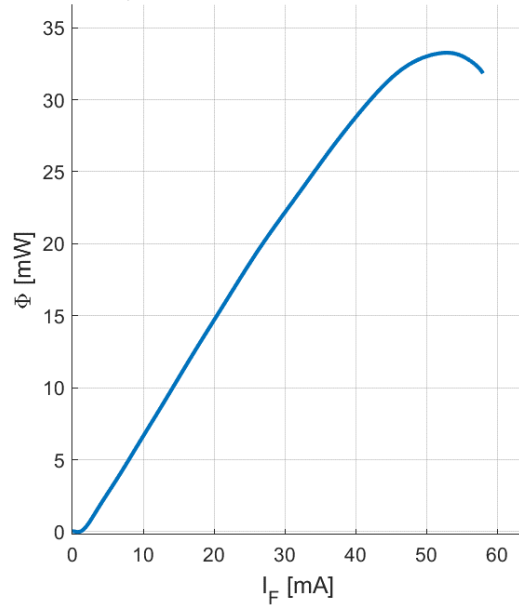

Relative Forward Voltage ¹⁾

$\Delta V_F = V_F - V_F(25\text{ °C}) = f(T_S); I_F = 15\text{ mA}$

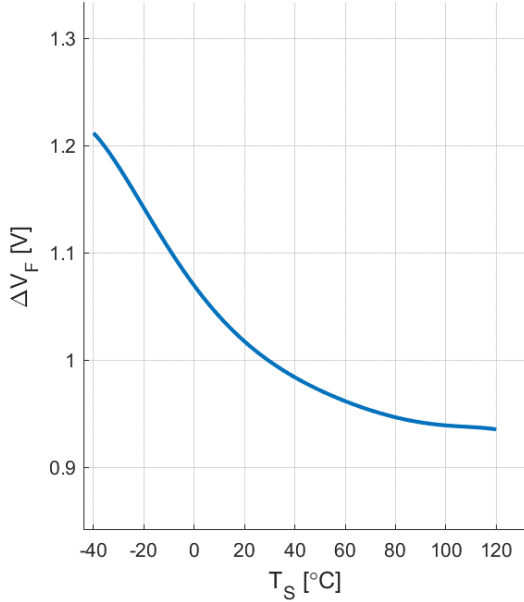

Relative Radiant Power ¹⁾

$\Phi / \Phi(25\text{ °C}) = f(T_S); I_F = 15\text{ mA}$

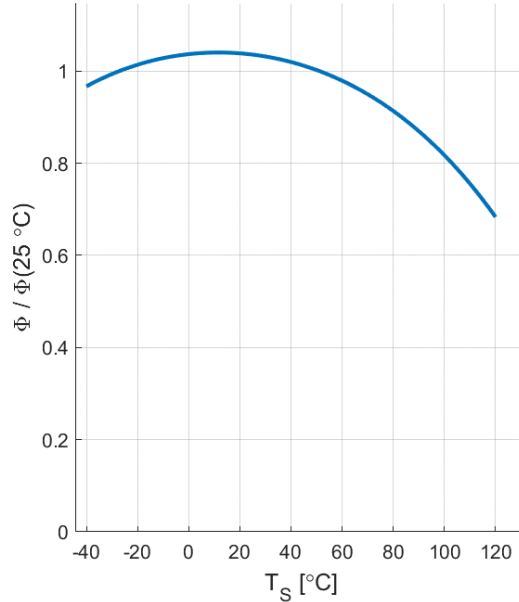

Max Permissible Current

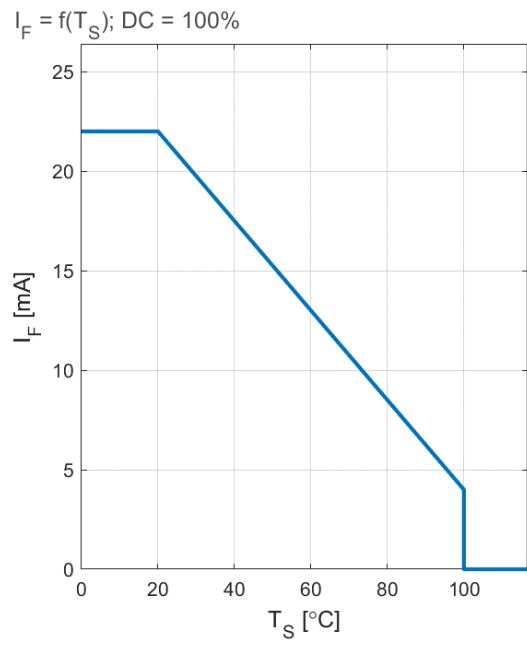

Dimension Drawings ³⁾

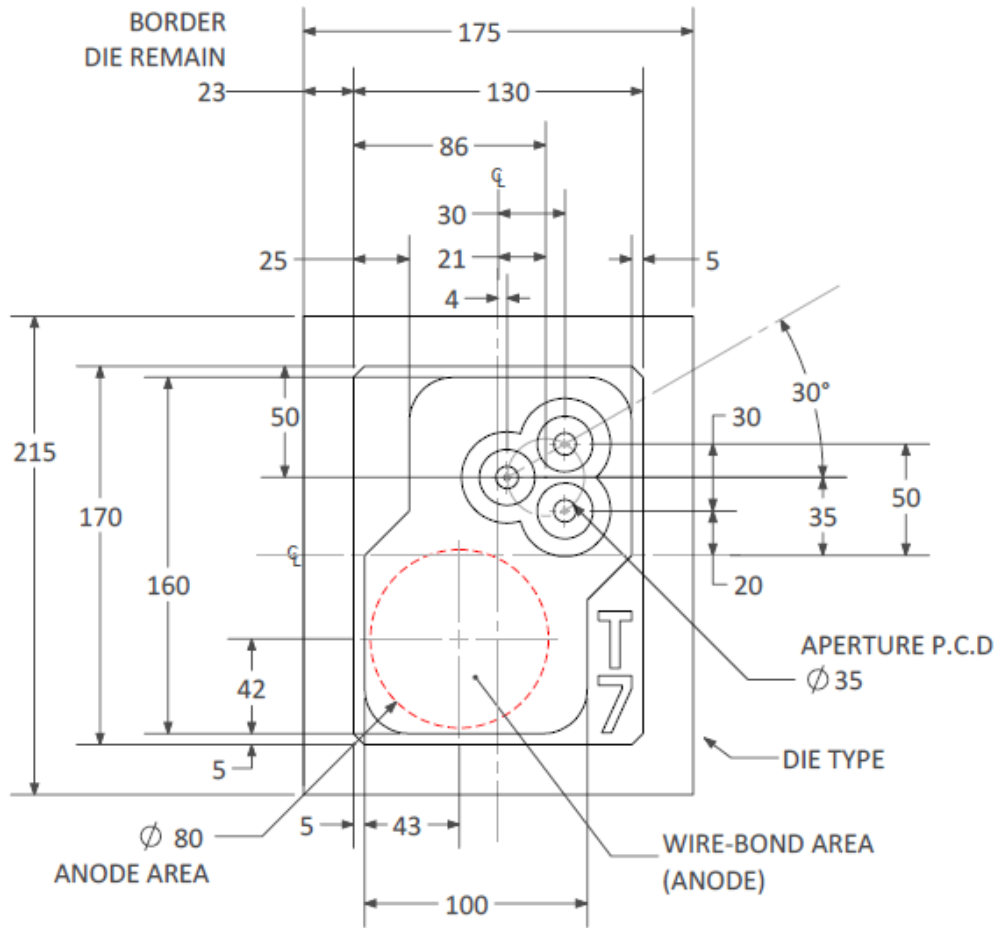

DASHED LINES (FOR WIRE-BOND AREA) ARE NOT VISIBLE ON ACTUAL DIE

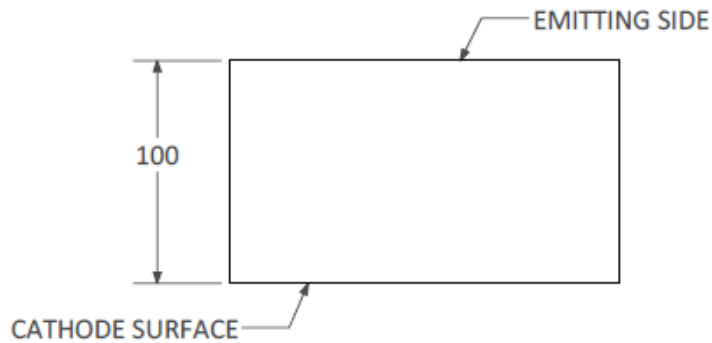

Product Label

VIXAR Vertical Cavity Surface Emitting Laser (VCSEL) Product

Model: _____

Manufacturer: VIXAR
2355 Polaris AVE N. SUITE 100
Plymouth, MN 55447 USA

Manufactured: Bare Die by VIXAR,
Fabricated or Packaged by: _____
City: _____, Country: _____

Wafer #: _____
Date Code: _____
Manufacturer Lot No.: _____
Quantity: _____

Complies with FDA/CDRH 21 CFR 1040.10 and 1040.11 except for deviations pursuant to Laser Notice No. 50, dated June 24, 2007.

CDRH Accession No.: 1210159-000

Product Code: RDW

Notes

Depending on the mode of operation, these devices emit highly concentrated visible and non-visible light which can be hazardous to the human eye. Products which incorporate these devices must follow the safety precautions given in IEC 60825-1.

Subcomponents of this device contain, in addition to other substances, metal filled materials including silver. Metal filled materials can be affected by environments that contain traces of aggressive substances. Therefore, we recommend that customers minimize device exposure to aggressive substances during storage, production, and use. Devices that showed visible discoloration when tested using the described tests above did show no performance deviations within failure limits during the stated test duration. Respective failure limits are described in the IEC60810.

For further application related information please visit vixarinc.com/vcsl-technology/application-notes

Glossary

- 1) **Typical Values:** Due to the special conditions of the manufacturing processes of semiconductor devices, the typical data or calculated correlations of technical parameters can only reflect statistical figures. These do not necessarily correspond to the actual parameters of each single product, which could differ from the typical data and calculated correlations or the typical characteristic line. If requested, e.g. because of technical improvements, these typ. data will be changed without any further notice.
- 2) **Testing temperature:** $T_a = 25^\circ\text{C}$
- 3) **Tolerance of Measure:** Unless otherwise noted in drawing, tolerances are specified with ± 0.1 and dimensions are specified in mm.

Revision History

Version	Date	Change
0.0	July 23 - 2020	Initiation of preliminary datasheet
1.0	March 2 - 2021	Release of datasheet



COMPLIES WITH IEC 60825-1, 3rd EDITION MAY 2014.
COMPLIES WITH 21 CFR 1040.10 AND 1040-10.11 EXCEPT FOR DEVIATIONS PURSUANT TO LASER
NOTICE NO.50 DATED 27 MAY 2001.