

V00129

**Assy; 2222; 850; M; 3B; P10X40; 4W;
1.26X1.26; AIN; 2835; 2L; 72X58**

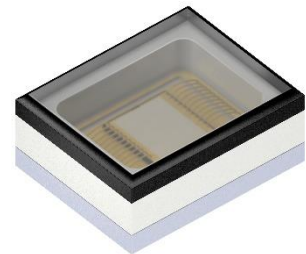

Applications

- Virtual Reality
- 3D Sensing
- Industrial Automation
- Access Control (IRIS/Vein Scan, Face Recognition)
- Augmented Reality, Mixed Reality
- Flash & Autofocus
- Gesture Recognition

Features:

- Package Description: SMD ceramic package with glass diffuser window
- Chip Technology: GaAs VCSEL power array
- Laser Wavelength: 850 nm
- Optical Power Class: 4 W
- Radiation Profile: 72°x58° (Rectangular emission profile)
- ESD: 8 kV acc. to ANSI/ESDA/JEDEC JS-001 (HBM, Class 3B)

Ordering Information

Description	Operating Mode:	Ordering Code
	$T_a = 25^\circ\text{C}$; $I_F = 5\text{ A}$; $t_p = 100\ \mu\text{s}$; DC = 1%	
Assy; 2222; 850; M; 3B; P10X40; 4W; 1.26X1.26; AIN; 2835; 2L; 72X58	4W	V00129



COMPLIES WITH IEC 60825-1, 3rd EDITION MAY 2014.
COMPLIES WITH 21 CFR 1040.10 AND 1040-10.11 EXCEPT FOR DEVIATIONS PURSUANT TO LASER
NOTICE NO.50 DATED 27 MAY 2001.

Maximum Ratings

$T_a = 25^\circ\text{C}$

Parameter	Symbol		Values
Operation/Solder temperature	T_S	min.	-40°C
DC = 100%		max.	110°C
Storage temperature	T_{stg}	min.	-40°C
		max.	110°C
Forward current	I_f	max.	18 A
Pulsed operation; $T_p = 100 \mu\text{s}$; DC = 1%; $T_S = 25^\circ\text{C}$			
Forward current	I_f	max.	8 A
Direct current operation; DC = 100%; $T_S = 25^\circ\text{C}$			
Reverse Voltage	Not designed for reverse operation		
Reflow soldering temperature	T_{Ref}	max.	260°C
ESD withstand voltage	V_{ESD}	max.	8 kV
acc. to ANSI/ESDA/JEDEC JS-001 (HBM, Class 3B)			

Note: Stresses beyond those listed under Absolute Maximum Ratings may cause permanent damage to the device.

Characteristics

$T_a = 25^\circ\text{C}$, $I_F = 5\text{ A}$; $t_p = 100\ \mu\text{s}$; DC = 1%

Parameter	Symbol		Values
Forward voltage	V_F	typ.	2.2 V
Output power	Φ	typ.	4.0 W
Threshold current	I_{th}	typ.	1.0 A
Slope efficiency	SE	typ.	1.0 W / A
Power conversion efficiency	η	typ.	36%
Peak wavelength	λ_{peak}	min.	840 nm
		typ.	850 nm
		max.	860 nm
Spectral bandwidth at FWHM (50% of Φ_{max})	λ_{FWHM}	typ.	2 nm
Temperature coefficient of wavelength	TC_λ	typ.	0.06 nm / K
Field of view at FWHM (HFOV)	$\theta_{ }$	typ.	72°
Field of view at FWHM (VFOV)	θ_{\perp}	typ.	58°
Thermal resistance junction/solderpoint	$R_{th, JS}$	typ.	15.9 K / W

Relative Spectral Emission 1)

$\Phi_{rel} = f(\lambda); I_F = 5 \text{ A}; T_S = 25 \text{ }^\circ\text{C}$

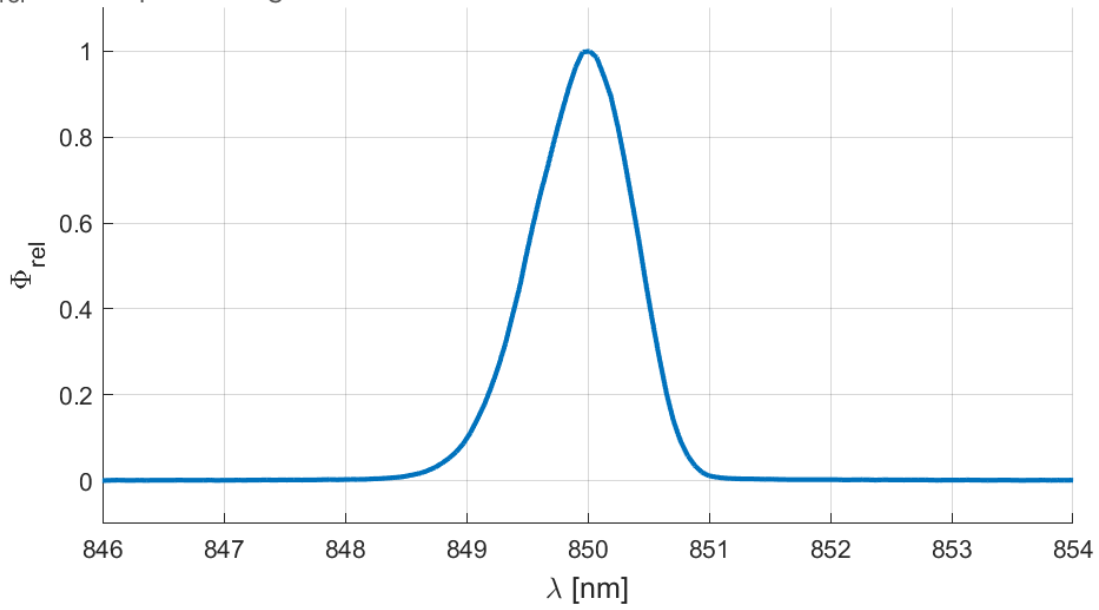

Radiation Characteristics 1)

$\Phi_{rel} = f(\phi); T_S = 20 \text{ }^\circ\text{C}$

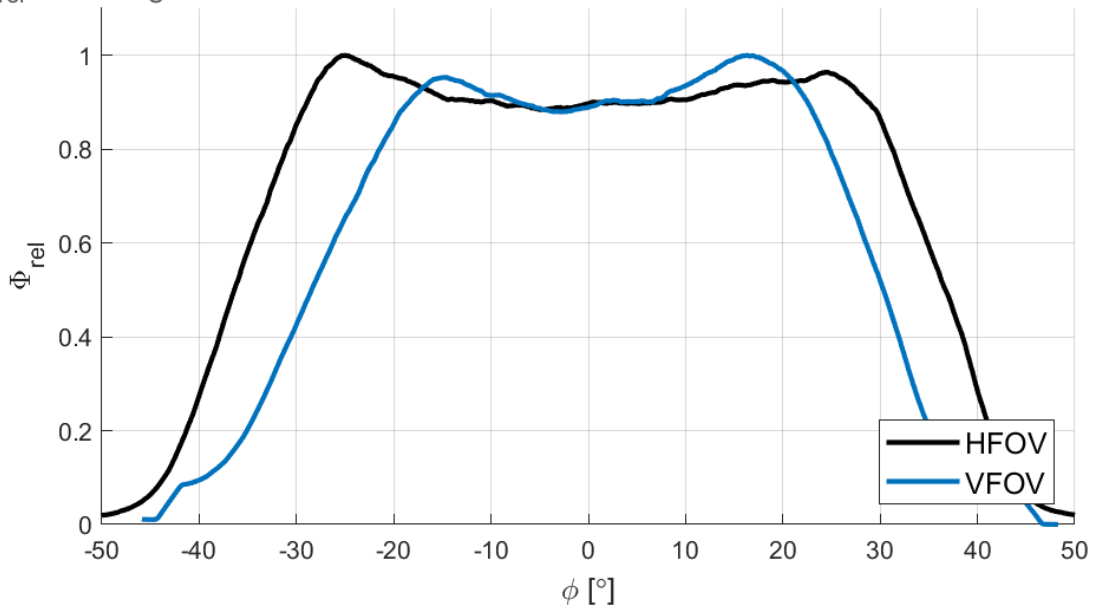

Forward Voltage ^{1) 2)}

$V_F = f(I_F); T_S = 25\text{ °C}; t_p = 100\ \mu\text{s}; \text{DC} = 1\%$

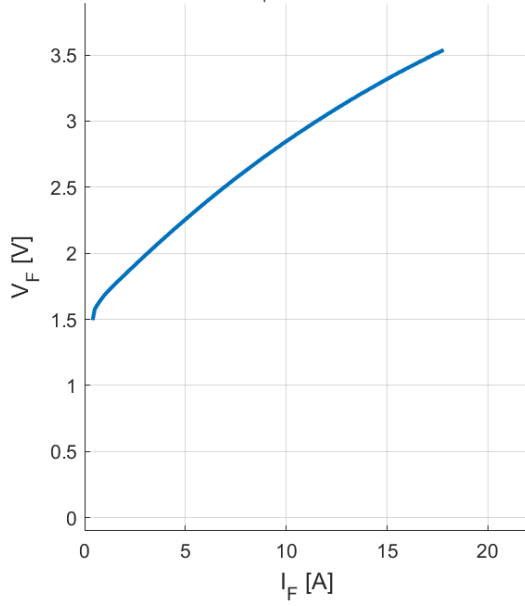

Optical Output Power ^{1) 2)}

$\Phi = f(I_F); T_S = 25\text{ °C}; t_p = 100\ \mu\text{s}; \text{DC} = 1\%$

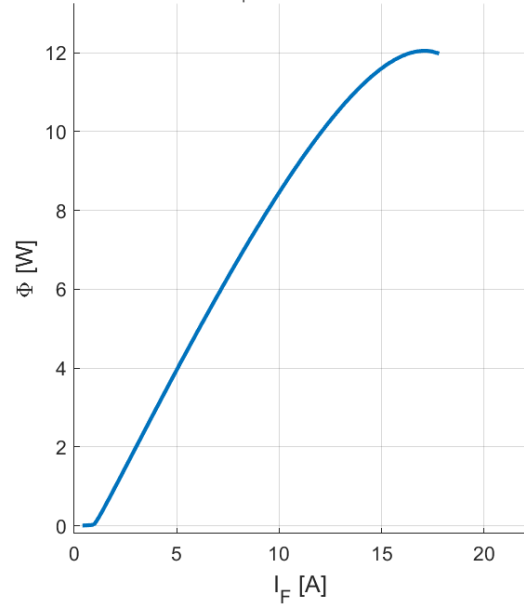

Relative Forward Voltage ¹⁾

$\Delta V_F = V_F - V_F(25\text{ °C}) = f(T_S); I_F = 5\text{ A}$

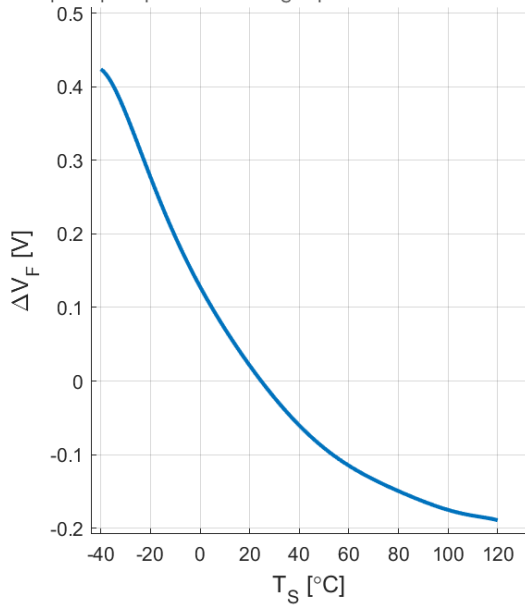

Relative Radiant Power ¹⁾

$\Phi / \Phi(25\text{ °C}) = f(T_S); I_F = 5\text{ A}; t_p = 100\ \mu\text{s}; \text{DC} = 1\%$

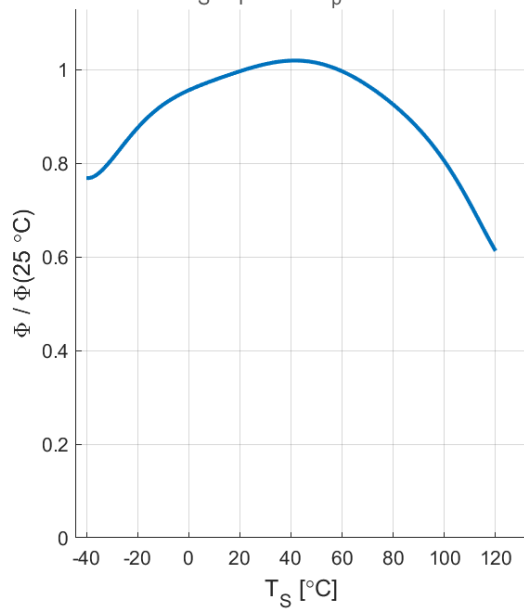

Max Permissible Pulse Current

$I_F = f(T_S); t_p = 100 \mu\text{s}; \text{DC} = 1\%; R_{\text{th,JS}} = 15.9 \text{ K/W}$

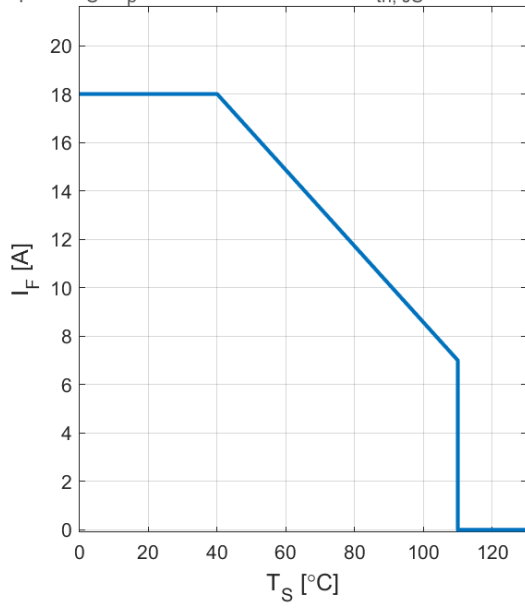

Max Permissible Current

$I_F = f(T_S); \text{DC} = 100\%; R_{\text{th,JS}} = 15.9 \text{ K/W}$

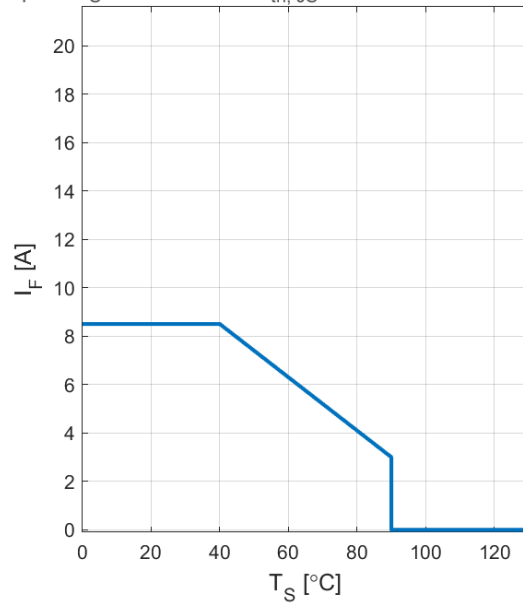

Dimension Drawings ³⁾

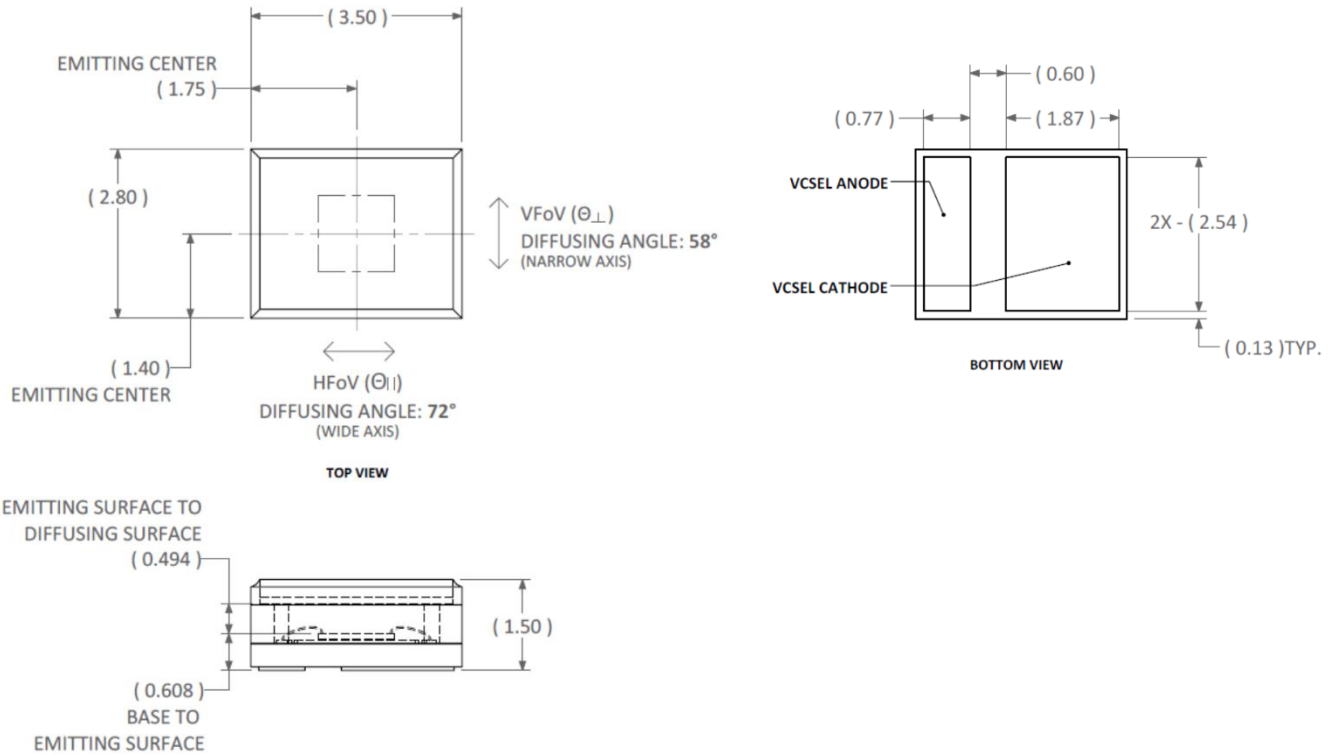

Further Information

Approximate Weight: 36 mg

Recommended Solder Pad Layout ³⁾

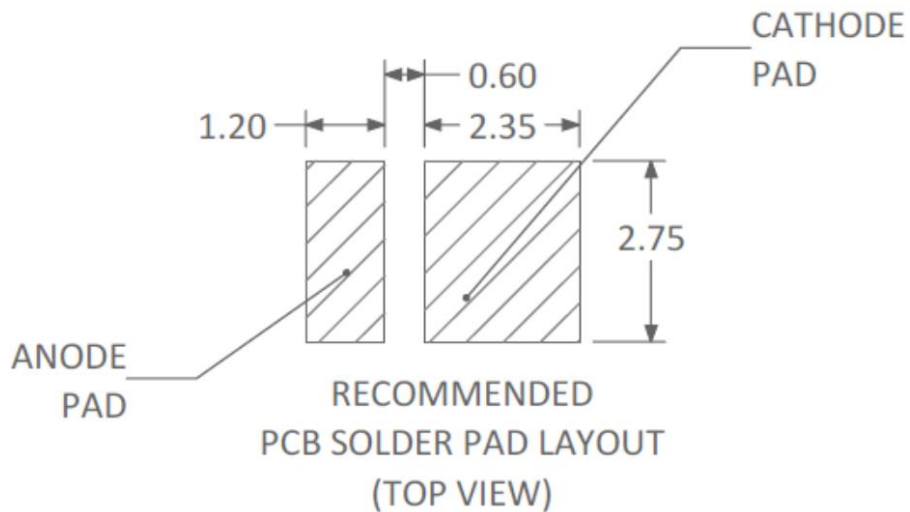

Reflow Soldering Profile

Product complies to MSL Level 2 acc. to JEDEC J-STD-020E

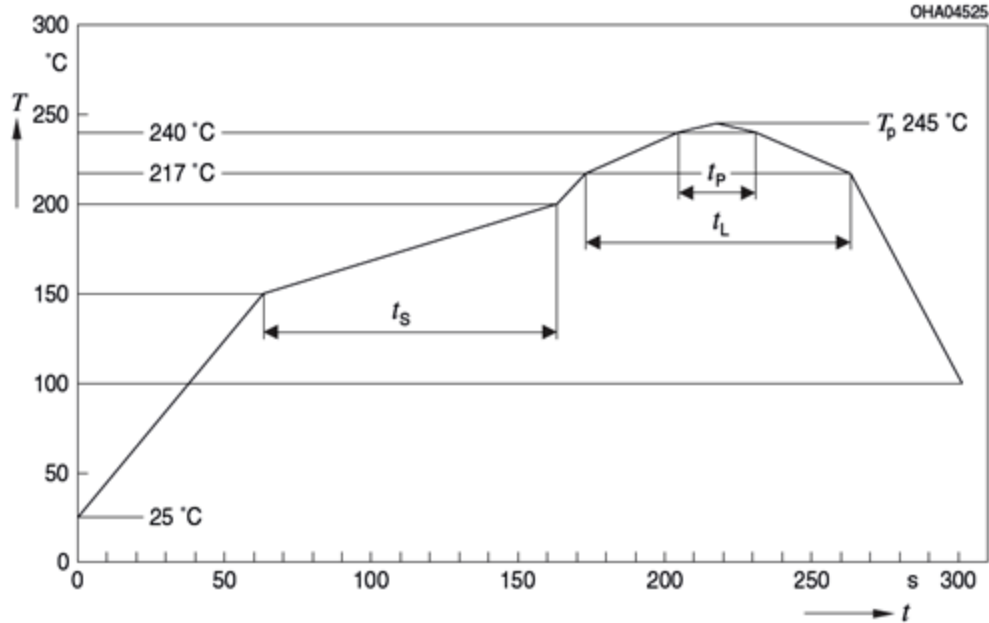

Profile Feature	Symbol	Pb-Free (SnAgCu) Assembly			Unit
		Minimum	Recommendation	Maximum	
Ramp-up rate to preheat ^{*)} 25°C to 150°C			2	3	K/s
Time t_s T_{smin} to T_{Smax}	t_s	60	100	120	s
Ramp-up rate to peak ^{*)} T_{Smax} to T_P			2	3	K/s
Liquidus temperature	T_L		217		°C
Time above liquidus temperature	t_L		45	60	s
Peak temperature	T_P		245	260	°C
Time within 5 °C of the specified peak temperature T_P - 5 K	t_p	10	20	30	S
Ramp-down rate* T_P to 100°C			3	6	K/s
Time 25°C to T_P				480	s

All temperatures refer to the center of the package, measured on the top of the component

*slope calculation DT/Dt : Dt max. 5s; fulfillment for the whole T-range

Taping ^{3) 4)}

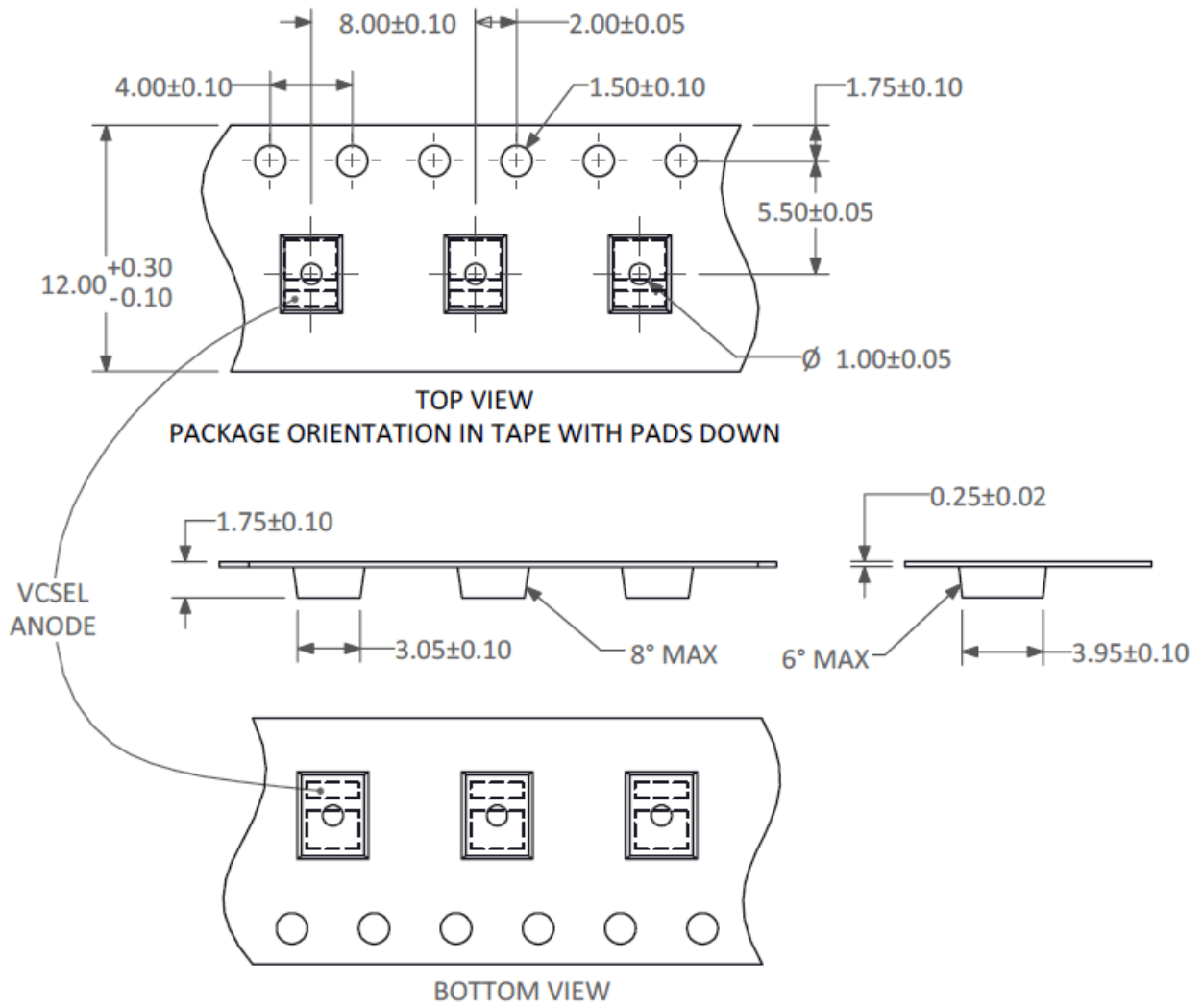

Tape and Reel 4)

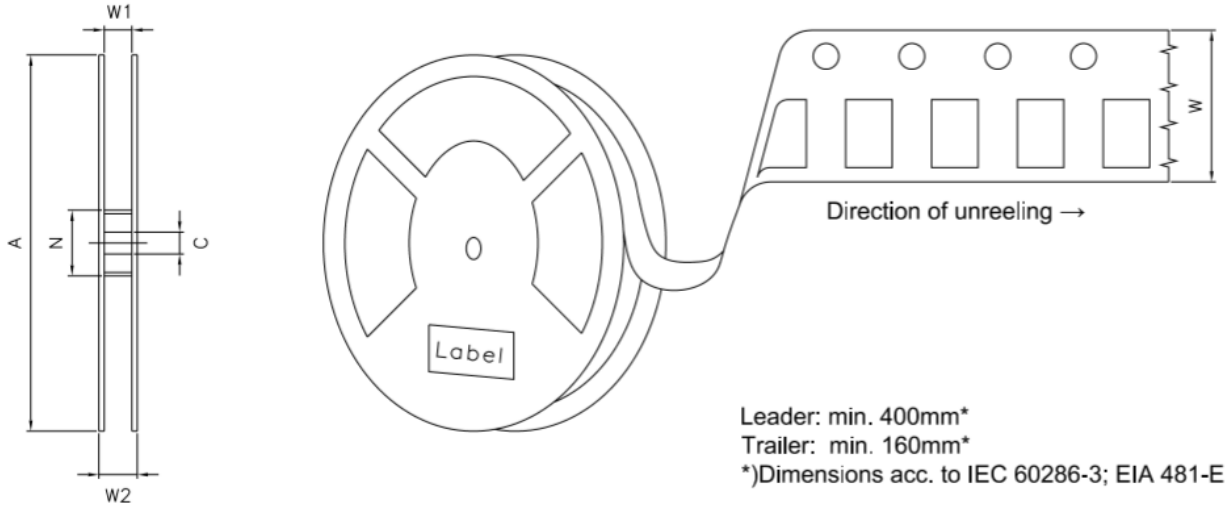

Reel dimensions [mm]

A	W	N _{min}	W ₁	W _{2 max}	Pieces per PU
330 mm	12 + 0.3 / - 0.1	60	12.4 + 2	18.4	2500

Product Label

VIXAR Vertical Cavity Surface Emitting Laser (VCSEL) Product

Model: _____

Manufacturer: VIXAR
 2355 Polaris AVE N. SUITE 100
 Plymouth, MN 55447 USA

Manufactured: Bare Die by VIXAR,
 Fabricated or Packaged by: _____

City: _____, Country: _____

Wafer #: _____

Date Code: _____

Manufacturer Lot No.: _____

Quantity: _____

Complies with FDA/CDRH 21 CFR 1040.10 and 1040.11 except for deviations pursuant to Laser Notice No. 50, dated June 24, 2007.

CDRH Accession No.: 1210159-000 Product Code: RDW

Notes

Depending on the mode of operation, these devices emit highly concentrated visible and non-visible light which can be hazardous to the human eye. Products which incorporate these devices must follow the safety precautions given in IEC 60825-1.

Subcomponents of this device contain, in addition to other substances, metal filled materials including silver. Metal filled materials can be affected by environments that contain traces of aggressive substances. Therefore, we recommend that customers minimize device exposure to aggressive substances during storage, production, and use. Devices that showed visible discoloration when tested using the described tests above did show no performance deviations within failure limits during the stated test duration. Respective failure limits are described in the IEC60810.

For further application related information please visit www.vixarinc.com/applications/application-notes

Glossary

- 1) **Typical Values:** Due to the special conditions of the manufacturing processes of semiconductor devices, the typical data or calculated correlations of technical parameters can only reflect statistical figures. These do not necessarily correspond to the actual parameters of each single product, which could differ from the typical data and calculated correlations or the typical characteristic line. If requested, e.g. because of technical improvements, these typ. data will be changed without any further notice.
- 2) **Testing temperature:** TA = 25°C
- 3) **Tolerance of Measure:** Unless otherwise noted in drawing, tolerances are specified with ± 0.1 and dimensions are specified in mm.
- 4) **Tape and Reel:** All dimensions and tolerances are specified acc. IEC 60286-3 and specified in mm.

Revision History

Version	Date	Change
1.0	June - 2020	Creation of Datasheet



COMPLIES WITH IEC 60825-1, 3rd EDITION MAY 2014.
COMPLIES WITH 21 CFR 1040.10 AND 1040-10.11 EXCEPT FOR DEVIATIONS PURSUANT TO LASER
NOTICE NO.50 DATED 27 MAY 2001.